

Pushbutton Enclosures - NEMA 12

1489/ 1489M Continuous Hinge Series

Operator Interface Enclosure

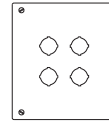

4

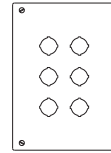

6

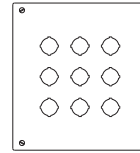

9

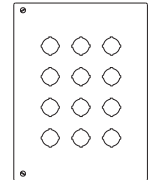

12

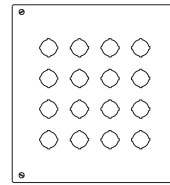

16

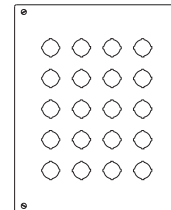

20

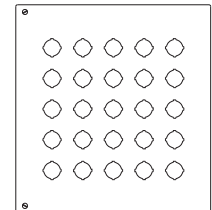

25

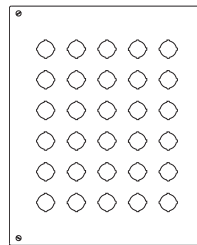

30

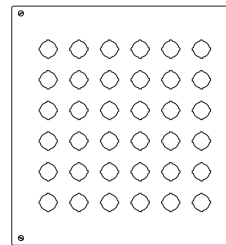

36

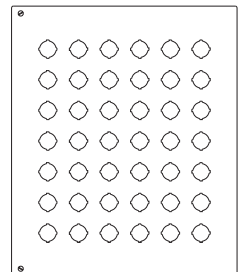

42

Pushbutton Enclosures

Application

- Designed to accept standard heavy duty oil tight pushbuttons, switches and pilot lights.
- Provides protection from dirt, dust, oil and water.

Standards

- UL 508 Type 12
- CSA Type 12
- JIC standard EGP-1-1967, EMP-1-1967
- **Complies with**
 - NEMA Type 12
 - IEC 60529, IP54
- Appropriate components are required to maintain these standards.

Construction

- Formed 14 gauge steel.
- Smooth continuously welded seams.
- Welded brackets provide for enclosure mounting.
- Continuously hinged cover is secured with captive, plated steel screws which fasten into threaded sealed wells.
- Oil resistant gasket and adhesive.
- Weldnuts are provided for mounting inner panels.
- A removable 14 gauge inner panel is included.
- A bonding stud is provided on the door and a grounding stud is provided in the enclosure.

Finish

- Cover and enclosure are phosphatized and finished in ANSI 61 gray powder coating.
- Removable inner panel is finished in white powder coating.

Accessories

- Hole plugs...see page 435
- Pedestals...see page 454

Pushbutton Enclosures - NEMA 12

1489/ 1489M Continuous Hinge Series

Operator Interface Enclosure

Pushbutton Enclosures

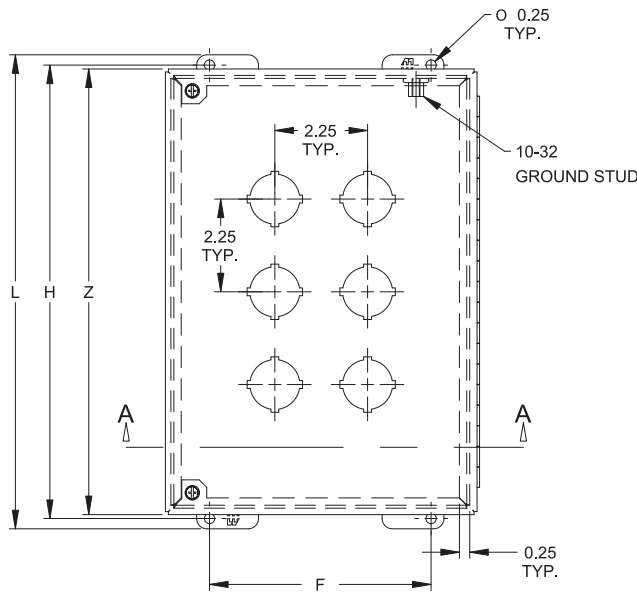

Front View

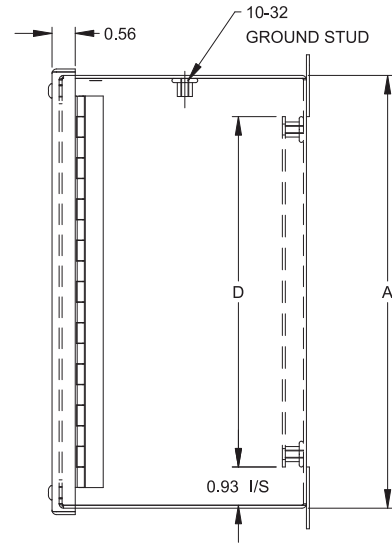

Side View

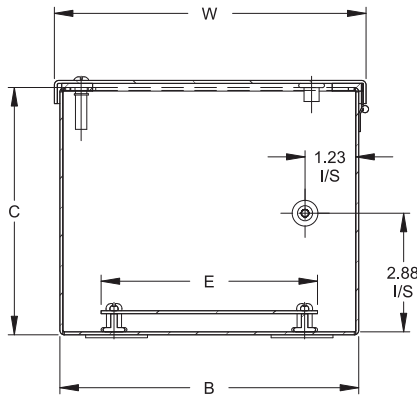

SECTION A-A

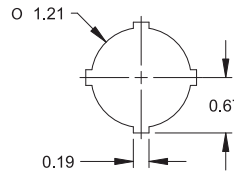

30.5mm Detail (1489 Series)

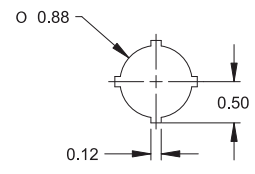

22.5mm Detail (1489M Series)

Part No.		No. Of Holes	Panel Size			Overall Dimensions				Ship Wt. Lbs.			
30.5mm Hole	22.5mm Hole		A	B	C	D	E	F	H		L	W	Z
1489P4	1489MP4	4	8.25	7.25	6	6.25	5.25	5.38	8.75	9.25	7.56	8.56	9
1489P6	1489MP6	6	10.5	7.25	6	8.5	5.25	5.38	11	11.5	7.56	10.81	11
1489P9	1489MP9	9	10.5	9.5	6	8.5	7.5	7.63	11	11.5	9.81	10.81	13
1489P12	1489MP12	12	12.75	9.5	6	10.75	7.5	7.63	13.25	13.75	9.81	13.06	15
1489P16	1489MP16	16	12.75	11.75	6	10.75	9.75	9.88	13.25	13.75	12.06	13.06	19
1489P20	1489MP20	20	15	11.75	6	13	9.75	9.88	15.5	16	12.06	15.31	21
1489P25	1489MP25	25	15	14	6	13	12	12.13	15.5	16	14.31	15.31	23
1489P30	1489MP30	30	17.25	14	6	15.25	12	12.13	17.75	18.25	14.31	17.56	28
1489P36	1489MP36	36	17.25	16.25	6	15.25	14.25	14.38	17.75	18.25	16.56	17.56	32
1489P42	1489MP42	42	19.5	16.25	6	17.5	14.25	14.38	20	20.5	16.56	19.81	29